

## Product description

Optical receiver OD007 (in text – receiver) is intended to convert optical SAT IF and DTT signals into electrical RF signals. Device is equipped with AGC based on RF output.

The receiver is powered via RF output connector from STB (Set-Top Box) or external 10-20 V DC power supply unit via DC IN connector.

Device is intended for indoor use only.

## Safety instructions

Installation of the receiver must be done according IEC60728-11 and national safety standards.

Any repairs must be done by a skilled personnel.

Supply voltage of receiver is up to 20 V. This voltage is not dangerous for life.

Output of PSU must have a short circuit protection.

To ensure safe operation of the receiver follow these instructions:

Do not plug the PSU into the mains supply until all cables have been connected correctly.

Avoid placing the receiver next to central heating components and in areas of high humidity.

If the receiver has been kept in cold conditions for a long time, keep it in a warm room no less than 2 hours before powering.





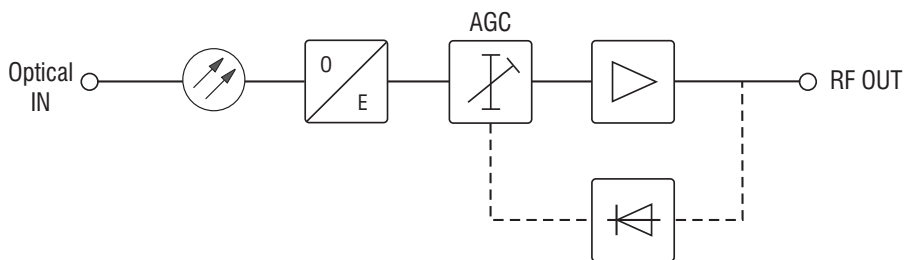

The receiver must be fixed with steel screws Ø 2.5-3.5 mm. The screws are not included in a package.

An optical connector after disconnection emits optical radiation.

Avoid looking directly into beam, laser light can cause eye injuries and result in permanent loss of vision.

## Structure diagram



-  This product complies with the relevant clauses of the European Directive 2002/96/EC. The unit must be recycled or discarded according to applicable local and national regulations.
-  Equipment intended for indoor usage only.
-  Functional grounding. Connect to the main potential equalization.
-  This product is in accordance to following norms of EU: EMC norm EN50083-2, safety norm EN IEC62368-1 and RoHS norm EN50581.
-  This product is in accordance with Custom Union Technical Regulations: "Electromagnetic compatibility of technical equipment" CU TR 020/2011, "On safety of low-voltage equipment" CU TR 004/2011.
-  This product is in accordance with safety standard AS/NZS 60065 and EMC standards of Australia.

## Application diagrams

①

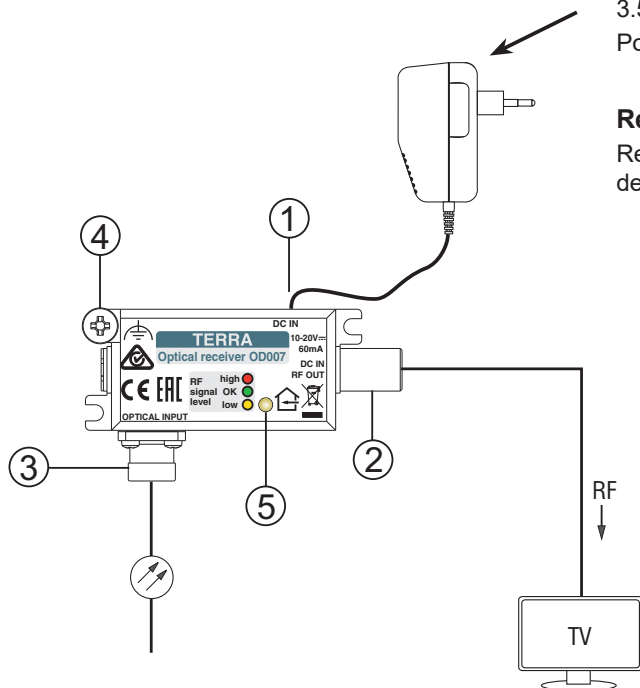

### Power supply unit 10V ÷ 20V DC

3.5 mm/1.3 mm or 5.5 mm/2.1 mm  
Power supply is not supplied with receiver.

### Reducer: socket 5.5 mm/2.1 mm, plug 3.5 mm/1.3 mm

Reducer is supplied in scope of the optical receiver delivery.

1. DC IN - connector 3.5 mm/1.3 mm
2. DC IN, RF OUT - RF signal output connector (F socket)
3. OPTICAL INPUT - optical input
4. Functional grounding clamp
5. LED output level indicator

## Requirements for external power supply unit

Output voltage range	+10 V min ...+20 V max
Output current	> 0.06 A
Output connector	type 3.5/1.3 (+) plug or type 5.5/2.1 (+) plug

- Short circuit protection
- Double insulated (marked )
- Meet EN 55022 class B conducted emissions requirements, measuring with grounded load

②

Powering from STB (Set-Top Box).

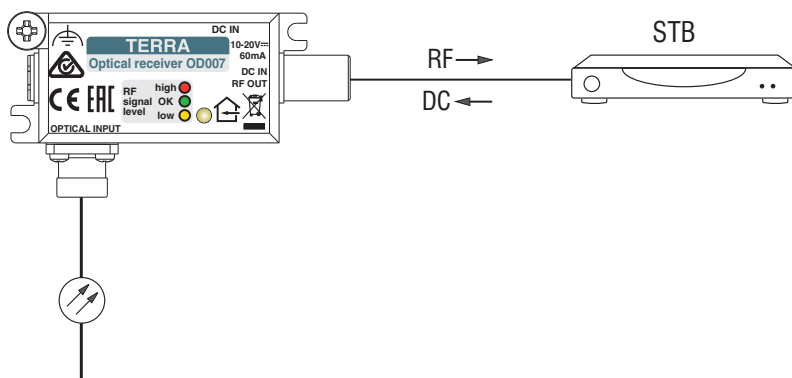

## Installation instructions

Read the product description and safety instruction first.

Fiber installation should be done very carefully. Bending radius of fibers must be not less 25 mm. An optical connector and adaptors should be cleaned before connecting them. Power on the receiver after all cables have been connected correctly.

## Technical characteristics

Optical input	optical wave length	1100-1600 nm
	optical input level* (AGC range)	-15 ...0 dBm
	optical return loss	> 40 dB
	noise current density	$\leq 7.0 \text{ pA}/\sqrt{\text{Hz}}$
RF output	frequency range	47-2400 MHz
	impedance	75 $\Omega$
	return loss	$\geq 14 \text{ dB}$ at 40 MHz -1.5 dB/oct., but not less 10 dB
	frequency response	$\pm 1.5 \text{ dB}$
Optical connector		FC / APC (OD007 F)
Optical connector		SC / APC (OD007 H)
Output level (AGC range) for 30 SAT IF transponders*		70 dB $\mu$ V (per transponder); 85 dB $\mu$ V (total level)
Supply voltage		10 V $\div$ 20 V
Current consumption		60 mA max.
Operating temperature range		-20° $\div$ + 50° C
Dimensions/Weight (packed)		71x39x19 mm/0.08 kg

\* optical input signal 4.9% OMI, 1310 nm, 30 SAT IF transponders

## Operating

The receiver output level indicator formed from LED:

Glowing **green**: output level constant 70 dB $\mu$ V (AGC range), optical input level range -15 ...0 dBm, optical input signal 4.9% OMI, 1310 nm, 30 SAT IF transponders;

Glowing **yellow**: level too low < 70 dB $\mu$ V, input signal is out AGC range;

Glowing **red**: level too high > 70 dB $\mu$ V, input signal is out AGC range.