

Product description

Optical receiver OD009 (in text – receiver) is intended to convert SAT IF, digital CATV and DTT signals from optical to electrical. Device is equipped with AGC based on optical input.

The receiver can be powered via RF OUT connectors from STB (Set-Top Box) or from external 10-20 V DC PSU (Power Supply Unit) via DC IN connector.

Device is intended for indoor use only.

Safety instructions

Installation of the receiver must be done according IEC60728-11 and national safety standards.

Any repairs must be done by a skilled personnel.

Supply voltage of receiver is up to 20 V. This voltage is not dangerous for life.

Output of PSU must have a short circuit protection.

To ensure safe operation of the receiver follow these instructions:

Do not plug the PSU into the mains supply until all cables have been connected correctly.

Avoid placing the receiver next to central heating components and in areas of high humidity.

If the receiver has been kept in cold conditions for a long time, keep it in a warm room no less than 2 hours before powering.





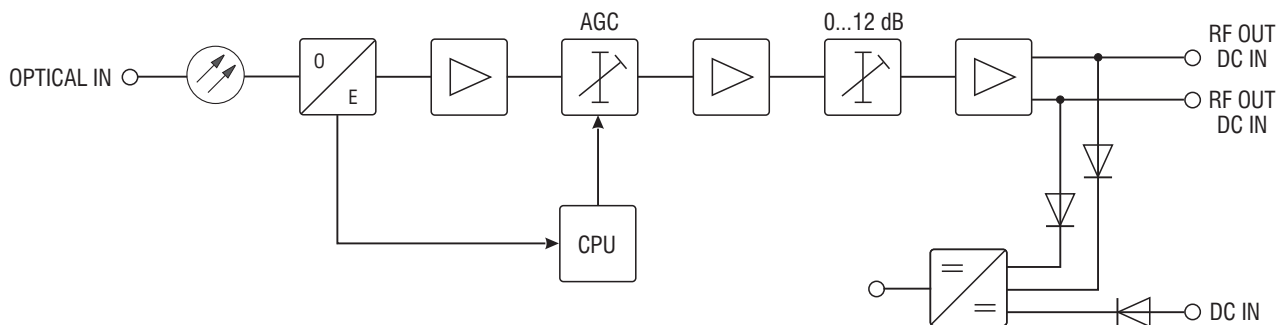

The receiver must be fixed with steel screws \varnothing 3 mm, the screws are not included in a package.

An optical connector after disconnection emits optical radiation.

Avoid looking directly into beam, laser light can cause eye injuries and result in permanent loss of vision.

Structure diagram



-  This product complies with the relevant clauses of the European Directive 2002/96/EC. The unit must be recycled or discarded according to applicable local and national regulations.
-  Equipment intended for indoor usage only.
-  Functional grounding. Connect to the main potential equalization.
-  This product is in accordance to following norms of EU: EMC norm EN50083-2, safety norm EN IEC62368-1 and RoHS norm EN50581.
-  This product is in accordance with Custom Union Technical Regulations: "Electromagnetic compatibility of technical equipment" CU TR 020/2011, "On safety of low-voltage equipment" CU TR 004/2011.
-  This product is in accordance with safety standard AS/NZS 60065 and EMC standards of Australia.

External view

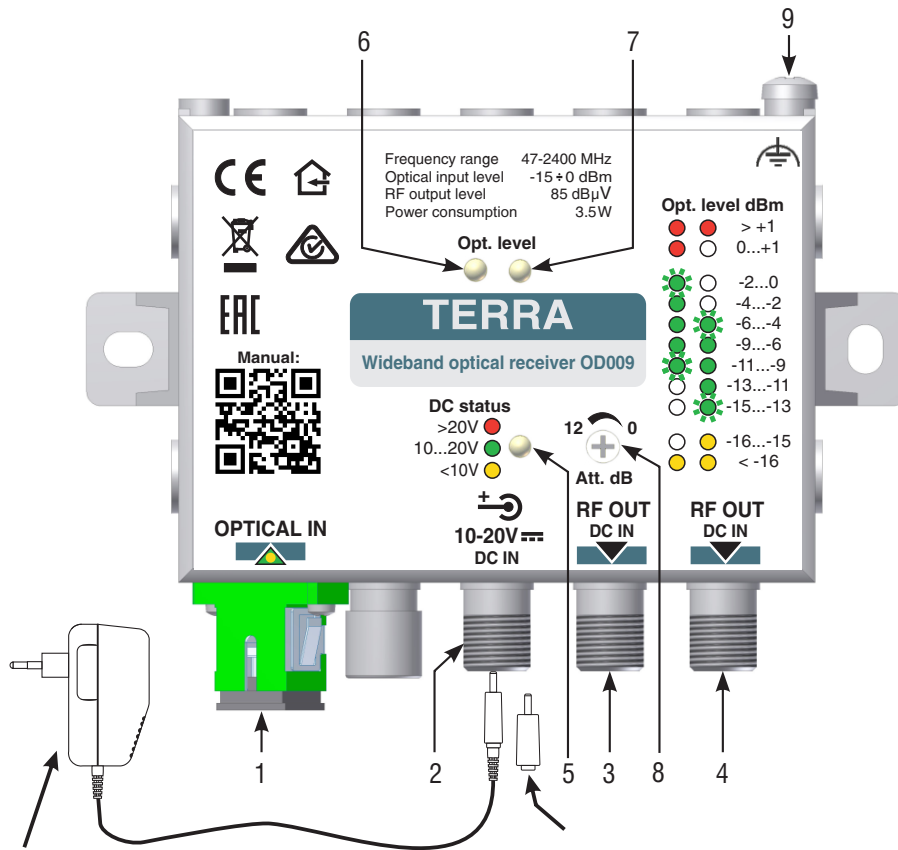

Power supply unit 10V ÷ 20V DC:
 3.5 mm/1.3 mm or 5.5 mm/2.1 mm;
 Power supply is not supplied with receiver.

Reducer:
 Socket 5.5 mm/2.1 mm, plug 3.5 mm/1.3 mm;
 Reducer is supplied in scope
 of the optical receiver delivery.

- 1. **OPTICAL IN** - optical connector SC/APC
- 2. **DC IN** - +10...+20 V DC powering input (connector 3.5 mm/1.3 mm)
- 3. **DC IN** 10 V ÷ 20 V, **RF OUT** - RF signal output connector (F socket)
- 4. **DC IN** 10 V ÷ 20 V, **RF OUT** - RF signal output connector (F socket)
- 5. LED indicator power supply voltage:
 red: > 20V to high
 green: 10...20V correct (AGC range)
 yellow: < 10V to low

6, 7. **Opt. level** - LED optical level indicators:

LED indicators		Optical level, dBm
red	red	> +1
red	not glowing	0...+1
blinking green	not glowing	-2...0
green	not glowing	-4...-2
green	blinking green	-6...-4
green	green	-9...-6
blinking green	green	-11...-9
not glowing	green	-13...-11
not glowing	blinking green	-15...-13
not glowing	yellow	-16...-15
yellow	yellow	< -16

- 8. RF outputs signal level regulator
- 9. Functional grounding clamp

Installation instructions

Read the product description and safety instruction first.

Fiber installation should be done very carefully. Bending radius of fibers must be not less 25 mm. An optical connector and adaptors should be cleaned before connecting them. Power on the receiver after all cables have been connected correctly.

Technical characteristics

Optical input	wavelength for receiver	1260-1620 nm
	connector	SC/APC
	return loss	> 50 dB
	input level (AGC range)	-15 ÷ 0 dBm
	noise current density	≤ 6 pA/√Hz
RF output	number of outputs	2
	frequency range	47-2400 MHz
	isolation between RF outputs	22 dB
	impedance	75 Ω
	return loss	≥ 12 dB up to 2400 MHz
	frequency response	± 1.5 dB
	output level (AGC range)	85 dBμV per carrier**
	spurious	< -40 dBc**
	output level adjustment range	0 ÷ 12 dB
Supply voltage	10 V ÷ 20 V	
Power consumption	3.5 W max.	
Current consumption	250 mA max.	
Operating temperature range	-20° ÷ + 50° C	
Dimensions/Weight (packed)	116x88x25.5 mm/0.28 kg	

* optical input signal OMI 4.9% , 30 SAT IF transponders and 8 DTT channels

** powering via RF outputs or dedicated 3.5/1.35 mm DC jack

REQUIREMENTS FOR EXTERNAL POWER SUPPLY UNIT

- Output voltage +10 V min ...+20 V max
- Output current > 250 mA
- Ripple at single and/or double mains frequency < 20 mV p-p
- Ripple & noise < 180 mV p-p
- Output connector type 3.5/1.3 (+) plug or type 5.5/2.1 (+) plug
- Short circuit protection
- Double insulated (marked )
- Meet EN 55022 class B conducted emissions requirements, measuring with grounded load