

Product description

Optical receivers (in text - receivers) are converting optical signals into electrical signals and amplify for further distribution TV signals in cable TV networks.

Receivers are powered from the mains 230 V~.

The receivers are intended for indoor use only.

Safety instructions

Installation of the receiver must be done according IEC60728-11 and national safety standards.

The receiver is powered from mains 230 V~. This voltage is dangerous to life.

Any repairs must be done by a skilled personnel.

Receiver is double isolated from the mains 230 V~.

To ensure safe operation of the receiver follow these instructions:

Do not remove the cover of the power supply section, without disconnecting the unit from the mains supply.

Do not plug the receiver into the mains supply if the power cord or plug is damaged.

Do not plug the receiver into the mains supply until all cables have been connected correctly.

The mains socket must be easily accessible.

Receiver shall not be exposed to dripping or splashing water.

Avoid placing receiver next to central heating components and in areas of high humidity.

If the receiver has been kept in cold conditions for a long time, keep it in a warm room no less than 2 hours before plugging into the mains.

Do not insert any objects into ventilation openings.

The ventilation should not be impeded by covering the ventilation openings with items, such as newspapers, table-cloths, curtains.

Mount in locations where children not likely to be present. Shields of cables must be connected to main potential equalization bus.

From top, front and bottom of installed receiver must be at least 10 cm free space.

An connector of optical cable after disconnection emits optical radiation.

Avoid looking directly into beam, laser light can cause eye injuries and result in permanent loss of vision.

External view

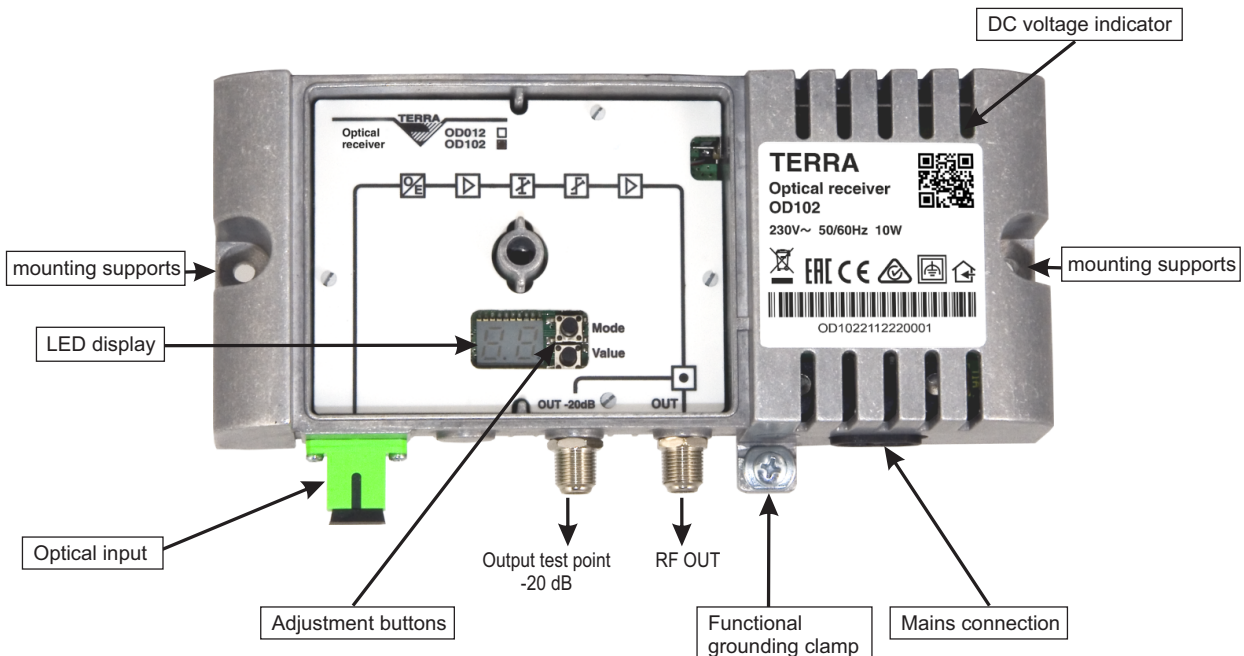

User Manual

Structure diagram

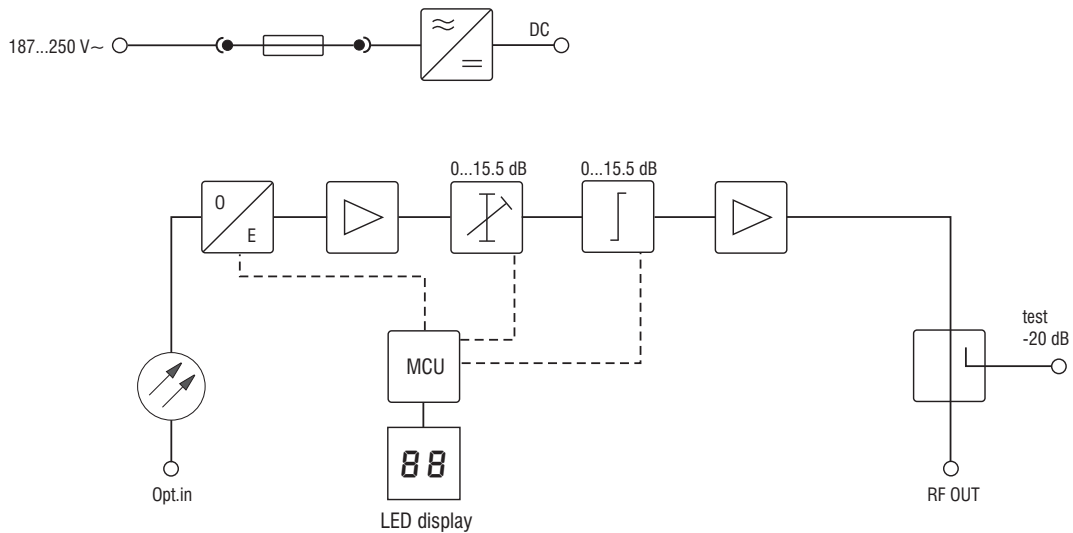

Installation

Read the safety instruction first.

Mount receiver in vertical position with optical connector underneath

From top, left and right side leave 10 cm free space.

Fasten with steel screws \varnothing 4-4.5 mm. Screws are not included in a package.

Fiber installation should be done very carefully. Bending radius of fibers must be not less 25 mm. All optical connectors and adaptors should be cleaned before connecting them.

Default settings

The receivers are supplied with the following default settings:

A1	AC
A2	0 dB
Eq	0 dB
Fr	Hi

After powering of module restarted the internal microcontroller recovers the settings before powering lost.

Operating and adjustment

There are adjustment buttons on the panel of the receiver. Parameters can be controlled and monitored with adjustments buttons. Values of parameters are displayed on LED display.

Adjustments buttons:

- button marked "Mode" is used for selecting parameter;
- button marked "Value" is used for changing value or monitoring.

The following parameters of the receivers can be changed or monitored:

- 1) **OL** - optical input power in dBm, when indicator is blinking - optical input power has a positive meaning, if not - negative.
- 2) **A1** - first attenuator, value (in dB): 0; 0.5; 1.0...19; 19.5; 20; AC. AC - automatic gain control (AGC). If this function is selected, the output level will be constant by changing optical input level in range -9... 2 dBm.
- 3) **A2** - interstage attenuator, value (in dB): 0; 0.5; 1.0; 1.5...15; 15.5.
- 4) **Eq** - interstage equalizer, value (in dB): 0; 0.5; 1.0; 1.5...15; 15.5.
- 5) **tE** - internal temperature.
- 6) **Fr** - frequency range: Lo: 47-862 MHz, Hi: 47-1006 MHz.

Technical characteristics

Type	OD012	OD102
Optical wavelength	1100-1600 nm	
Optical input level (OLC range)	-9 ... 2 dBm	
Optical return loss	>40 dB	>45 dB
Noise current density	≤ 6.5 pA/√Hz	
Frequency range (pr.)	47-862 MHz / 1006 MHz	
Impedance	75 Ω	
Return loss	≥ 14 dB/40 MHz-1.5 dB/oct	≥ 18 dB/40 MHz-1.5 dB/oct
Frequency response	± 0.75 dB	
Output level (OLC controlled, 3.5% OMI)	108 dBμV	114 dBμV
Output level (CTB, EN60728-3)*	108 dBμV (42 ch.)	114 dBμV (42 ch.)
Output level (CSO, EN60728-3)*	108 dBμV (42 ch.)	114 dBμV (42 ch.)
Interstage attenuator (pr.)	0-15.5 dB by 0.5 dB step	
Interstage equalizer (pr.)	0-15.5 dB by 0.5 dB step	
Loss in test point	-20 dB ± 0.7 dB	
Supply voltage limit values, power consumption	187-250 V~ 7.5 W	187-250 V~ 10 W
Optical connector	SC/APC	
RF connectors	F	
Operating temperature range	-20° ÷ + 50° C	
Dimensions/Weight (packed)	185.5x95x47 mm/0.9 kg	

* output level (CTB, CSO) is measured with 9 dB interstage equalizer, OMI 3.5%, OLC on, 1310 nm, @-3 dBm









(pr.) software control

Diagnostic

Internal microcontroller scans and collects diagnostic data.

Diagnostic information is displayed on internal LED display. Meanings of diagnostic messages see in table.

Diagnostic messages on LED display	Comments
E1	no input signal
E2	AGC out of range
E4	overheat
E3	no input signal and AGC out of range
E5	overheat and no input signal
E6	AGC out of range and overheat
E7	no input signal, AGC out of range and overheat

-  Risk of electric shock.
-  This product complies with the relevant clauses of the European Directive 2002/96/EC. The unit must be recycled or discarded according to applicable local and national regulations.
-  Equipment intended for indoor usage only.
-  Equipment is double insulated from the mains, with functional earthing.
-  Functional earthing. Connect to the main potential equalization.
-  This product is in accordance to following norms of EU: EMC norm EN50083-2, safety norm EN IEC62368-1 and RoHS norm EN50581.
-  This product is in accordance with Custom Union Technical Regulations: "Electromagnetic compatibility of technical equipment" CU TR 020/2011, "On safety of low-voltage equipment" CU TR 004/2011.
-  This product is in accordance with safety standard AS/NZS 60065 and EMC standards of Australia.